

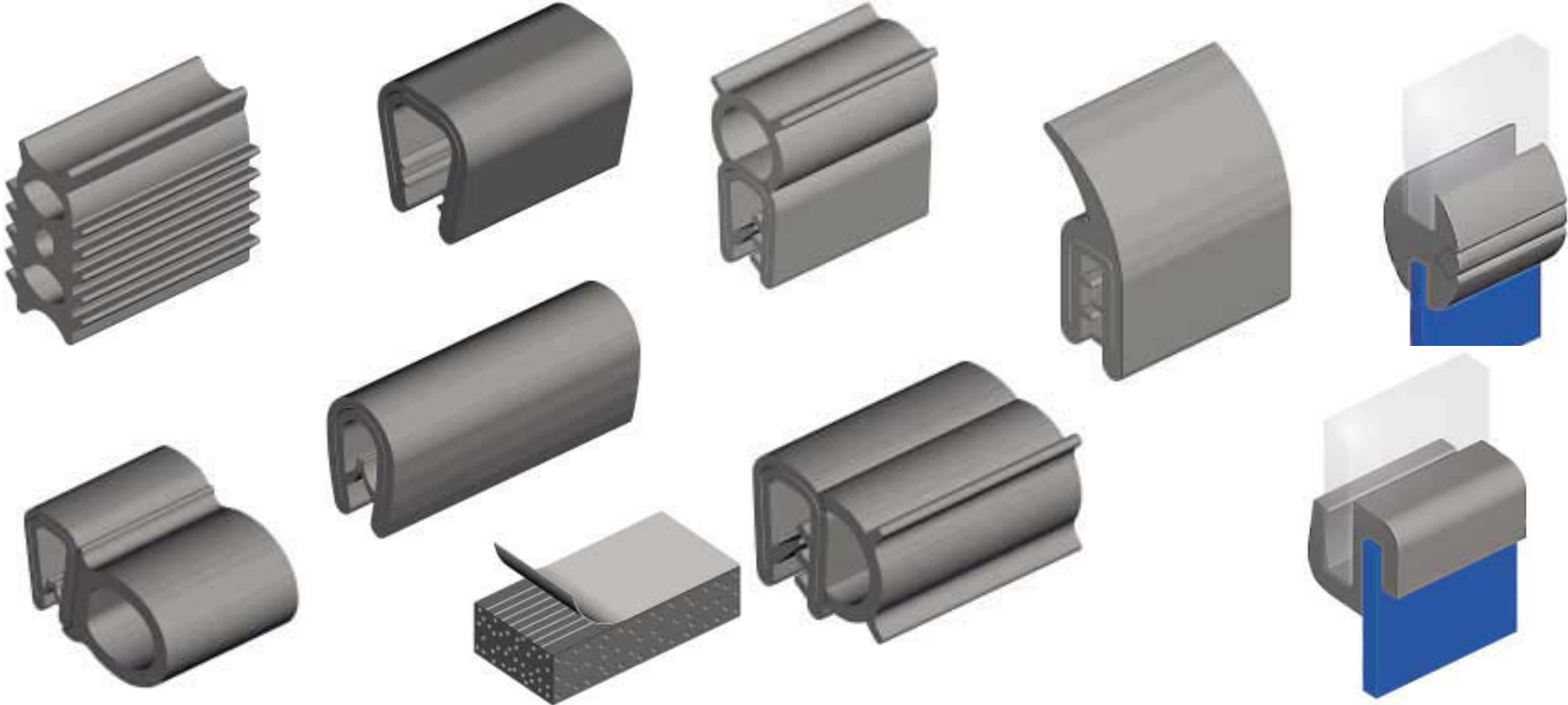

# GASKETING



# EMKA Gaskets



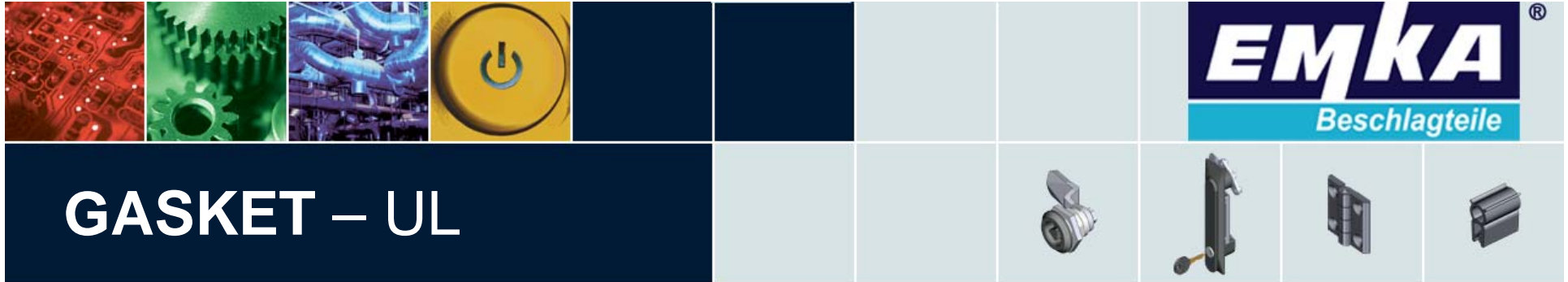

## GASKET – UL

Some of our EPDM gaskets are UL listed (see catalog); this is printed on the side of the gasketing.

Those gaskets listed by UL have passed a heat aging test (UL file #MH13838). This is 7 days at 70°C (158°F) without deterioration and is accepted as a good indicator of long life. They also have passed the UL 94 HB test for low flammability when in a horizontal position (UL file #E206536).

To verify our UL status go to [UL.com](http://UL.com) and search for “emka\*” (the asterisk is important.)



# GASKET Bulb Vs. Foam

## PRO

- QUALITY & RELIABILITY
- Better sealing
- Lower installation costs
- Lower closing force
- More compliant
- Long life

## CON

- Needs radiussed corners – this does increase the cost of manufacture and must be weighed against all the benefits
- More expensive per foot

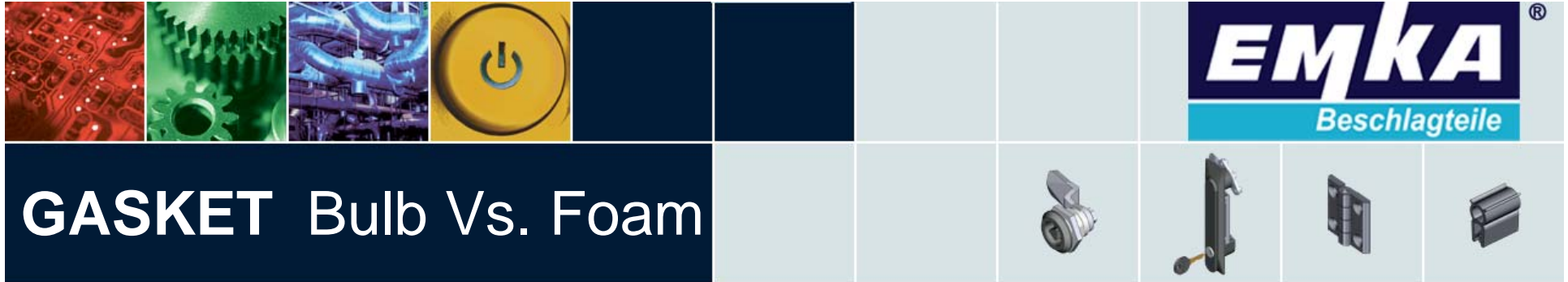

## GASKET Bulb Vs. Foam

### BETTER SEALING

- Bulb gasket is very compliant, it can accommodate large manufacturing tolerances of gap width without causing excessive force or leaks.
- Many profiles have 3 sealing points.
- The gasket is installed in one piece so there is only one joint and this can be positioned at the bottom and easily sealed.
- The low compression forces needed to seal bend the door a relatively small amount, this keeps variations in gap width to a minimum.



# GASKET - Sealing



## Standards

Standard	Protection against	Other
<b>NEMA 4 &amp; 4X / UL 50</b>	Hosed and splashing water	4X includes corrosion resistance
<b>NEMA 3</b>	Rain	Dust protected
<b>NEMA 12</b>	Dripping liquids	Dust protected
<b>GR 487</b>	70 MPH wind-driven rain	Dust protected
<b>IP 54</b>	Splashing water	Dust protected
<b>IP 65</b>	Water jets	Complete dust protection
<b>IP 66</b>	Powerful water jets	Complete dust protection
<b>IP 69K</b>	High Pressure hot water	Complete dust protection



**LOWER INSTALLATION COSTS**  
**&**  
**HIGHER QUALITY**



- **Does not require great care in order to minimize leaks at corners.** *EMKA foam gasket has a fabric reinforced backing to help minimize this problem*
- **Does not require cutting to length 4 times.**
- **Does not require careful cleaning of the surface**
- **Faster installation increases overall productivity**

*Stainless enclosure on the outside of a jetway*

Typical installation of self-adhesive foam gasket clearly showing one of 4 potential gaps.



## LOWER CLOSING FORCE

- High closing forces often lead to the use of compression latches, if multiple latches are needed these are independent (or very expensive) so the technician must remember to close each latch every time.
- A handle attached to three latching points ensures that all points are latched.
- The higher the force of the gasket on the door the more the door will bend, potentially allowing leakage, or requiring extra latching points and hinges.

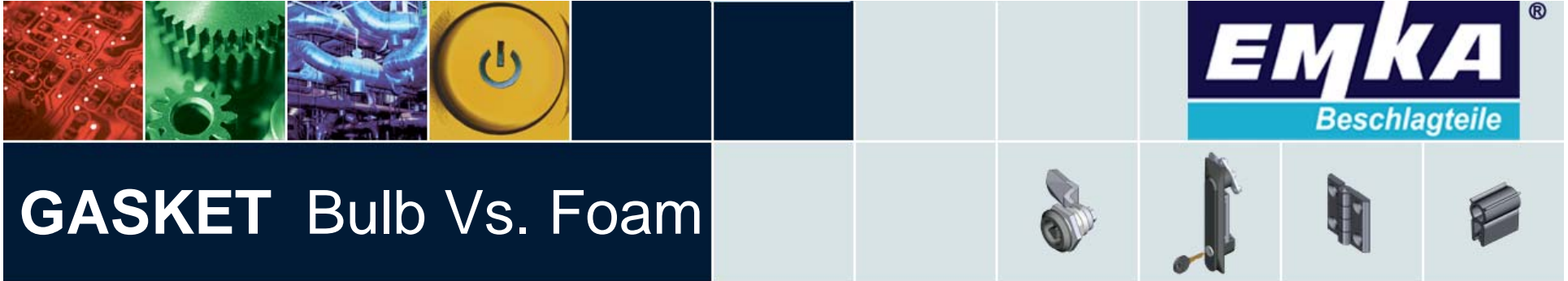

## MORE COMPLIANT

- In a less than perfect world the gap that the gasket fills is not consistent. With a compliant (bulb type) gasket the force difference between the minimum and maximum gaps is much less than with a foam gasket. Also the minimum force to seal with a bulb gasket is less therefore the total force on the door is about  $\frac{1}{4}$  of that with a foam gasket.
- This means fewer latches and hinges, each with lower forces, less door deformation.
- Use of a compliant gasket results in a less expensive enclosure with better, more reliable sealing.





## LONGER LIFE



- **EPDM (Ethylene Propylene Diene Monomer) is almost impervious to weathering - water, UV, ozone, high ambient temperatures. 30 year rubber roofs use EPDM.** The same chemistry that resists environmental attack resists adhesion. So foam gaskets are rarely made from 100% EPDM.
- **Where oil is present Nitrile rubber is an excellent alternative although more expensive and not quite so resistant to weathering**
- **Minimal compression set means that sealing forces remain relatively constant over time.**
  - The photograph shows compression set with a foam gasket as well as the water leak route.

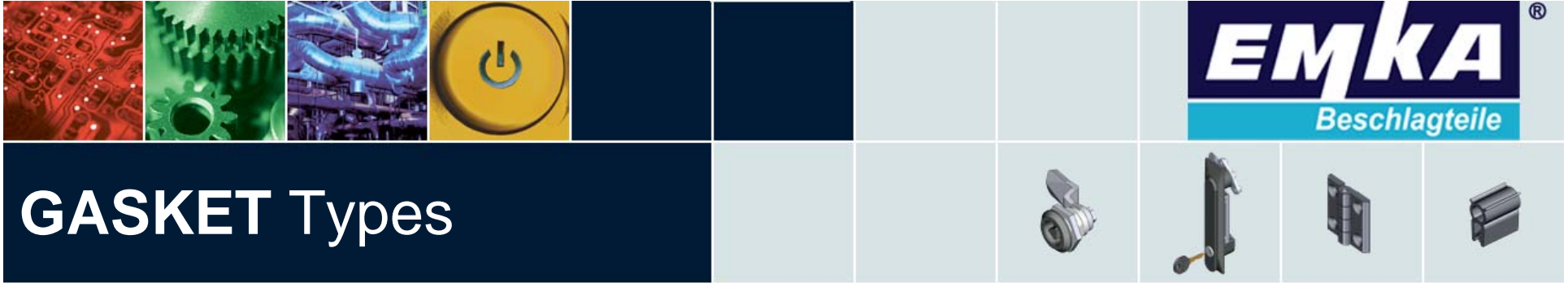

## LONGER LIFE



- **All EPDM The carrier material is vulcanized to the bubble part for the highest possible strength.**
- **EPDM on a PVC carrier. This is two extrusions glued together. PVC is a hard plastic, to make it flexible a significant amount of plasticizer is added. As the extrusion ages this plasticizer migrates to the surface, destroying the bond to the EPDM. Making this gasketing is a 3 step process, to be price competitive inferior materials are often used.**

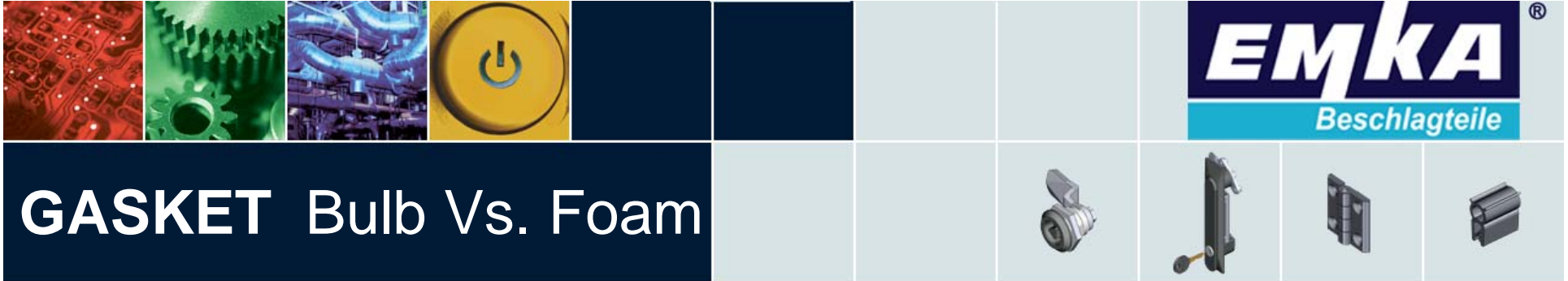

## LOWER COST OF QUALITY

1. A consequence of better, more reliable, sealing is that leak testing may no longer be necessary.
2. Because of the long life expectancy of EPDM and the reduced compression set, warranty claims are cut.
3. Installation of foam gasket is fraught with pitfalls
  - a. Four lengths must be cut accurately
  - b. Surface must be clean and grease-free
  - c. Gasket must be positioned, without wrinkles or stretching, exactly abutting the other gasket strips
4. If an enclosure has adjustable latches (e.g. compression latches) it is almost certain that cost reduction can be achieved by using bubble gasket and fixed cam latches. Parts, installation & quality costs will drop.



# GASKET - Materials



Operating Temperatures	EPDM	Nitrile (NBR, BUNA N)	Chloroprene (Neoprene)
Minimum °F / °C	-60 / -50	-40 / -40	-45 / -42
Maximum °F / °C	250 / 120	210 / 100	210 / 100
<b>Chemical Resistance</b>			
Weathering	E	G	G - E
Ozone	E	P	G
Oils	P	E	G - E
Acids	F	G	F - G
Alcohols	E	G - E	G - E
Polar Solvents (ketones)	P	E	P
Water	E	G	G
<b>Mechanical Properties</b>			
Compression set	G	G	F - G
Abrasion resistance	G	G - E	G - E

“Weathering” includes UV resistance. EPDM is inherently resistant because it is a saturated compound with few double bonds for the UV to attack. Also the carbon black in the mix is an excellent absorber of UV.

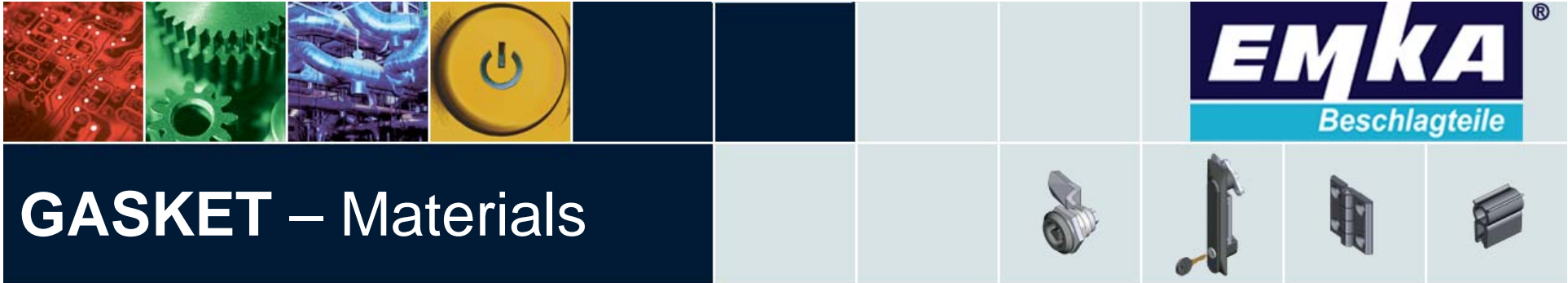

**The preceding table is a guide only. For the following reasons we strongly advise rigorous testing under actual conditions.**

- Many industrial fluids contain an unknown mixture of chemicals.
- Temperature and concentration of the chemical and any stress may make a significant difference to its effects on the gasket.
- Elastomers become softer at higher temperatures and more brittle as temperatures fall, how cold is too cold depends on the amount of flexing and shock loading; how hot is too hot depends on how much stress and what chemicals (e.g. O<sub>3</sub>) the gasket is subject to.

Other gasket material that will be encountered are TPEs (thermoplastic elastomers) and Silicone. TPEs available in many different varieties with a great range of properties, it is impossible to know how these without more details. Silicone is resistant to most common chemicals and high and low temperatures, however its combination of poor tear strength and high coefficient of friction mean that it is easily damaged, it is quite expensive.

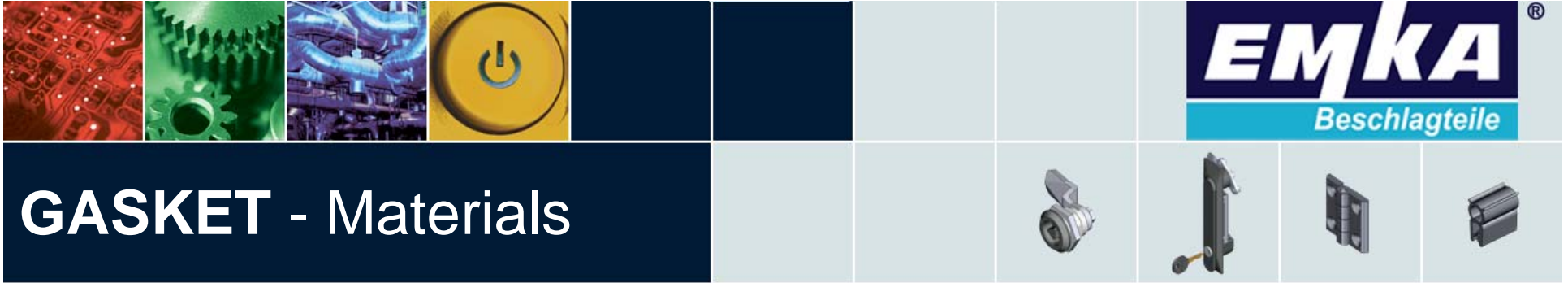

If the gasket is exposed to UV EPDM should be selected

In machine tool applications, the compositions of cutting oils are proprietary, we have had success with NBR, but also some failures



**Top bubble**



**Side bubble**

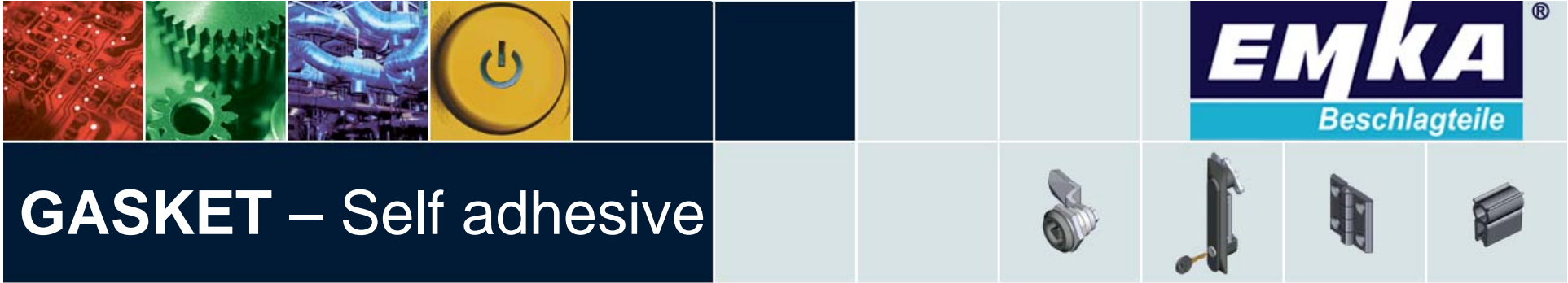

## GASKET – Self adhesive

Two materials – EPDM / SBR blend for non-oily applications and Neoprene (Chloroprene) for where oil is present.

Fabric backing – the main reason self-adhesive gaskets leak is that in order to apply them without wrinkles they have to be stretched, so when they are released a gap forms as shown.

EMKA gasket has a non-stretch fabric back which overcomes this.

The photo also shows where the gasket has taken a “set.”

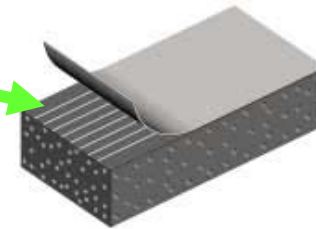

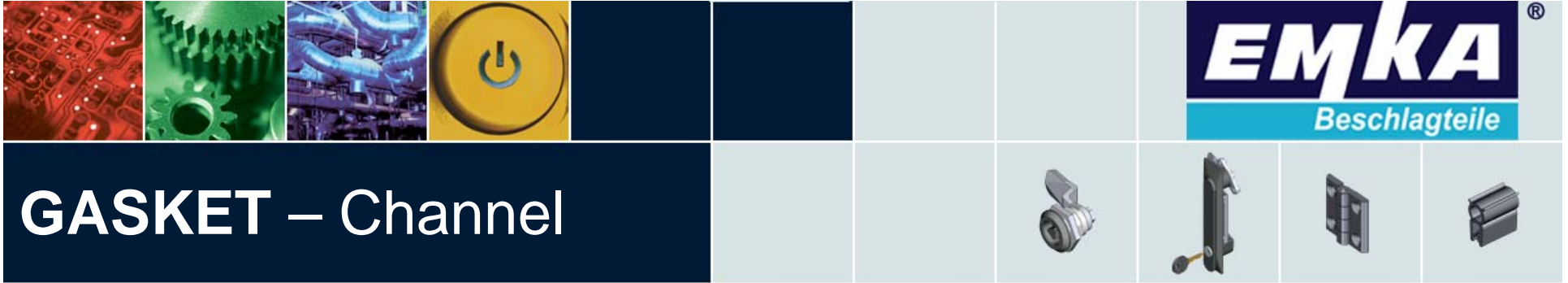

## GASKET – Channel

1. Inexpensive
2. Good for Right Angle corners
3. Needs a channel – a flange welded on as a stiffener allows the use of this type of gasket and lighter gauge steel for the whole door.





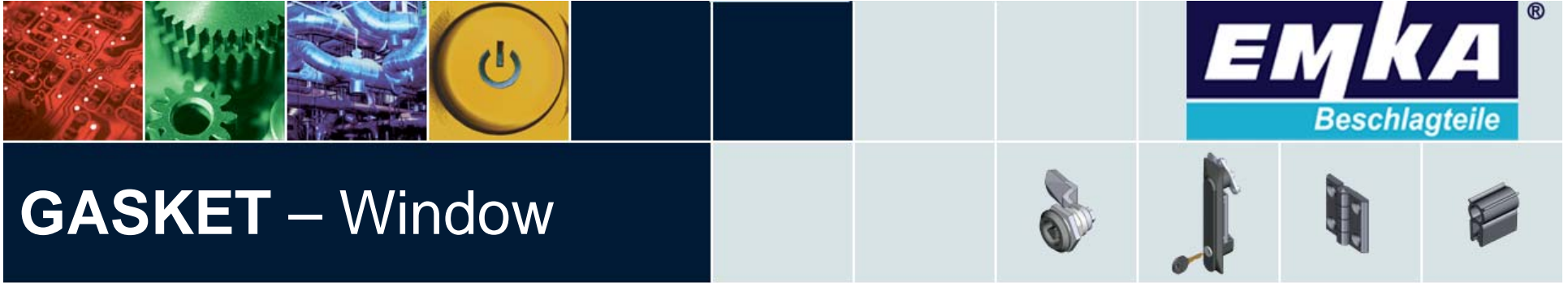

1. Two piece – EPDM only, great outside no good for machine tool guards if coolant is present. Use the tool for easier installation



2. “S” type not as good a seal as the two piece, but easier to install and available in NBR.

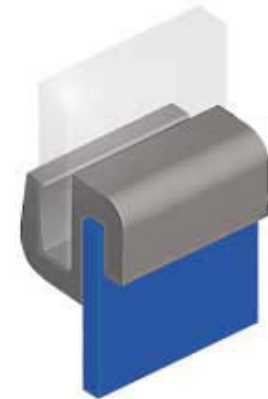

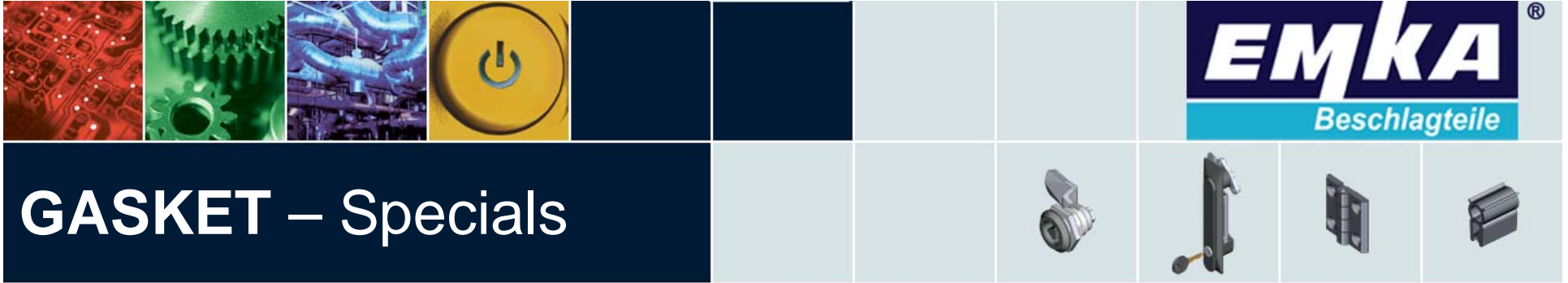

## GASKET – Specials

1011-XX-E EMI shielding Gasket. This comprises silvered nylon fabric bonded to standard EPDM gasket. The fabric has a corrosion resistant coating. This does not provide a consistent water seal.

1011-S19 Fire resistant gasket (1011-05 profile). Typically 5,000m MOQ, this is not always required. Other profiles are tooled. NOTE: The rubber (EPDM) is a softer compound than standard.

1011-XX-09 For HVAC applications. The surface is designed to inhibit the growth of bacteria and other pathogens which can spread infection and death (Legionnaires' Disease). The rubber (EPDM) is a softer compound than standard.

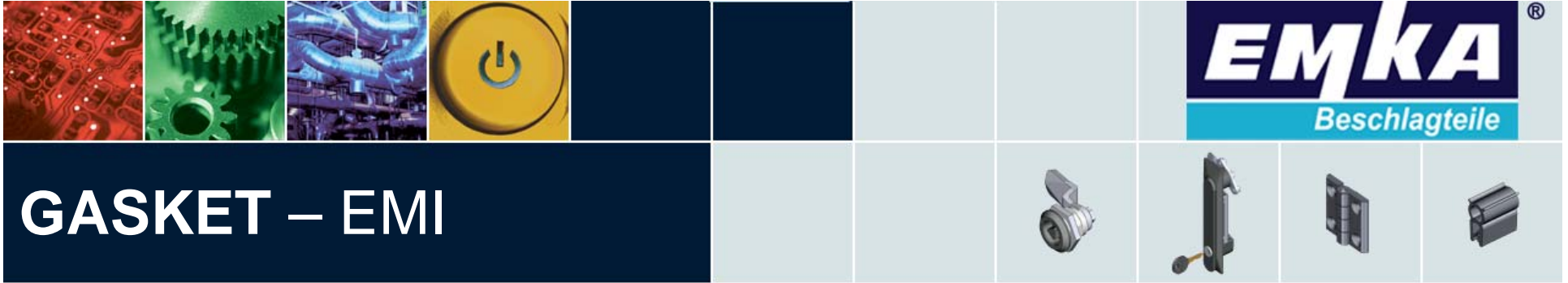

## GASKET – EMI

EMKA's EMI shielding products attenuate "aperture leakage" of electromagnetic radiation. These help the fabricator to produce cost effective EMC enclosures.

Gasketing does double duty, it solves the main EMI problem: leakage around the door, and also provides a water and dust barrier (not to NEMA 4).

This gasketing is relatively easy to install, reducing both total cost and the possibility of error.

EMKA also produces conductive and grounded latches and swinghandles

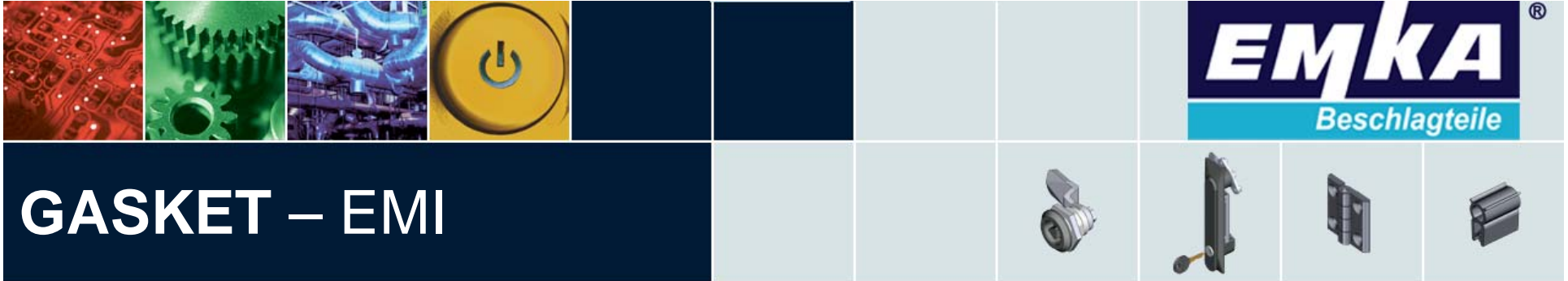

## GASKET – EMI

For optimal shielding the gasket must be grounded to both the door and the frame of the enclosure. For steel or aluminum the metal must be masked so that the conductivity is not compromised by corrosion.

Conductive tape is easy to install and gives a very reliable, long lasting, conductive surface that is highly resistant to even galvanic corrosion.

EMI gasket is also available in 4 rectangular sections:  $\frac{1}{2}$ " x  $\frac{1}{8}$ ",  $\frac{1}{2}$ " x  $\frac{1}{4}$ ", 8 x 5mm and 15 x 4mm. These are constructed from the same conductive fabric over polyurethane foam. All sections have a pressure sensitive adhesive on one side.



# GASKET – EMI

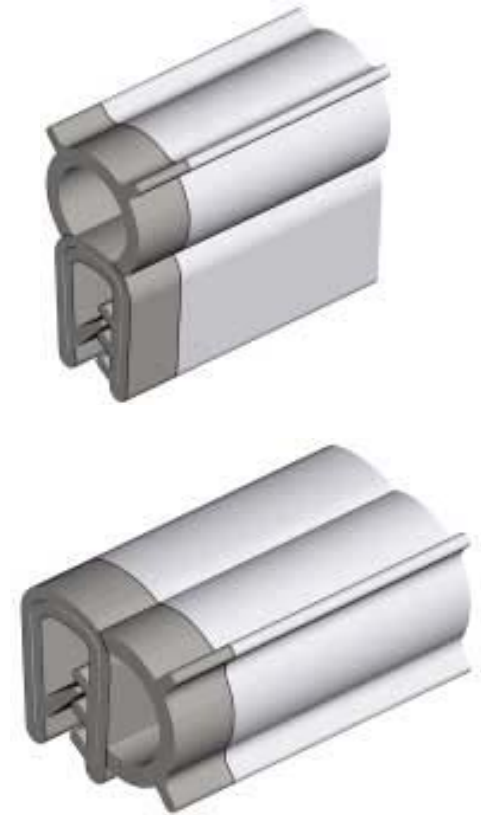
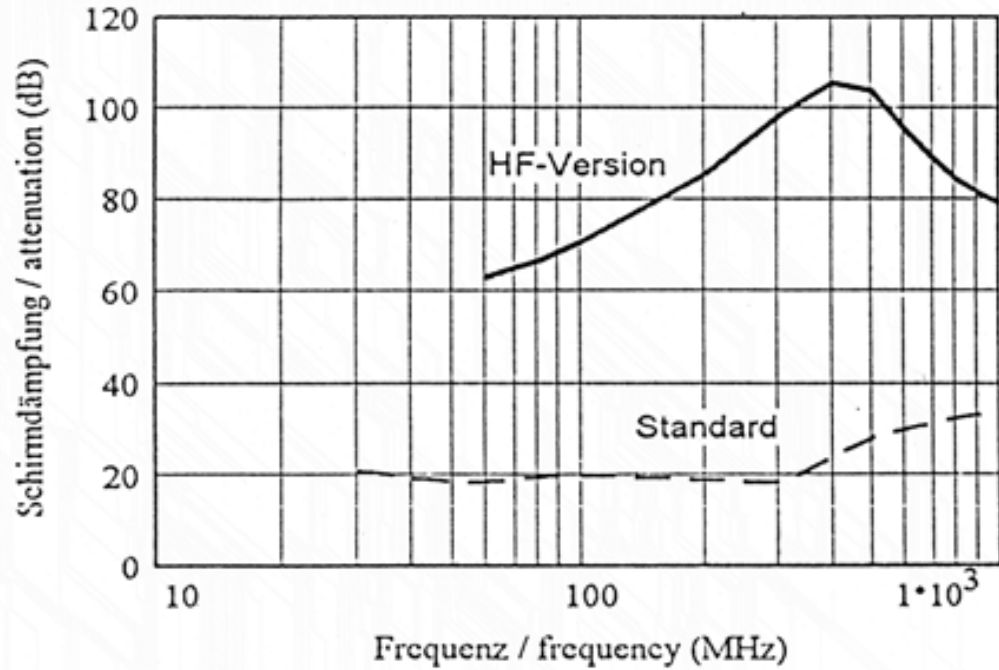

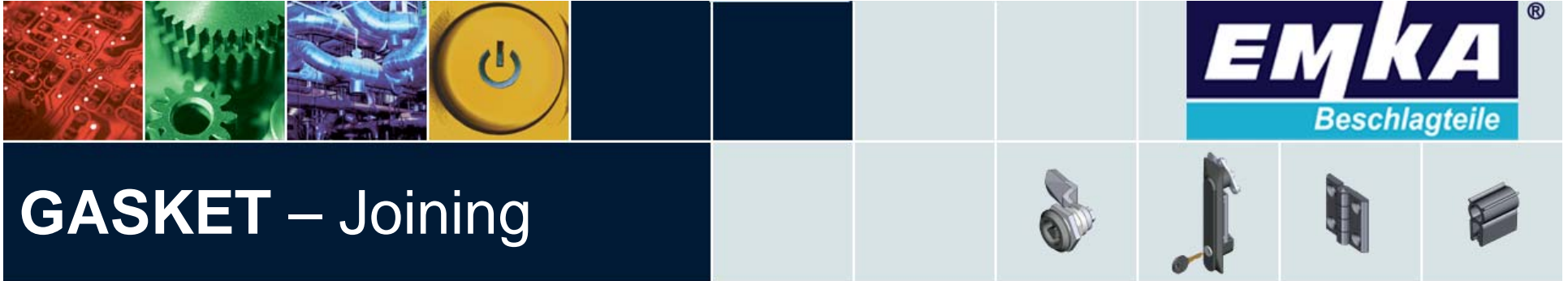

## GASKET – Joining

### BEST SOLUTION

Gaskets can be vulcanized endless at the factory, this may require some tooling investment for profiles other than 1011-05, 1011-06 and 1011-10. This produces a strong and flexible joint, which seals out water and eliminates corrosion.

Corners can also be vulcanized giving a one piece, quick to install “frame.” This eliminates the need for the enclosure manufacturer to radius the corners – a very significant added value.

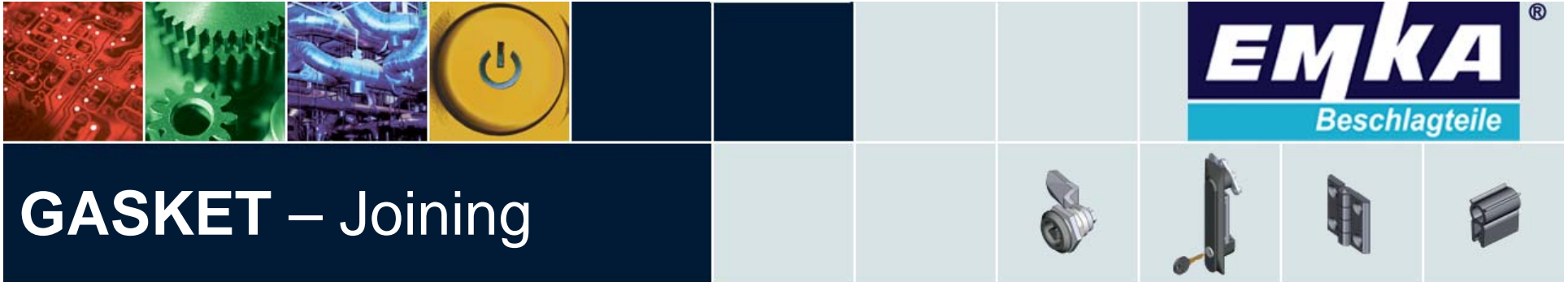

## ON-SITE SOLUTION

If the clip-on gasket is cut on site it can easily be cut slightly oversize so it is compressed at installation leaving no gap.

If joining the ends is essential Black Max from Loctite will give a good, but inflexible, bond. If flexibility is required most rubber distributors sell “cold vulcanizing” adhesive specifically for EPDM.